

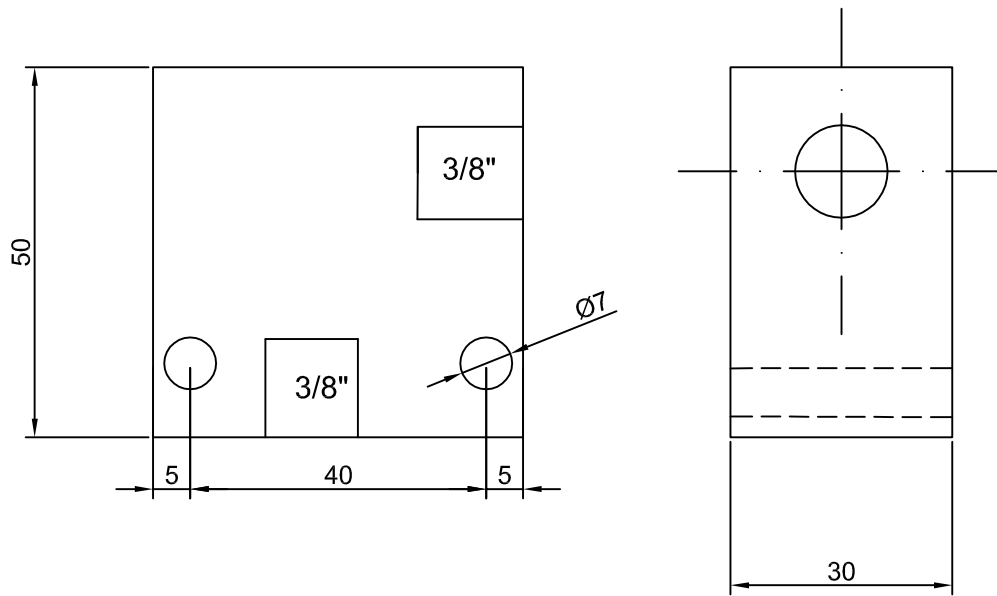

Nr	Ant	Ändring	Datum	Inf	Godk
----	-----	---------	-------	-----	------



Pos. nr	Antal	Modellbeteckning			Beskrivning		Referens	
Konstr	Ritad HS	Kop	Kontr	Stand	Godk	Skala 1:1	Ersätter	Ersatt av
 Material: Aluminium Ports: G=3/8"							Filnamn	Datum
							Ritning.nr VB82-06	